

Customer to verify height Following grade rings available upon request:
 CP24-2
 CP24-3
 CP24-4
 CP24-6
 Larger heights available upon request.

D&L 1024 Frame and Covers marked SEWER provided at extra cost.

23" concrete lid. Optional frame and cover

Side View

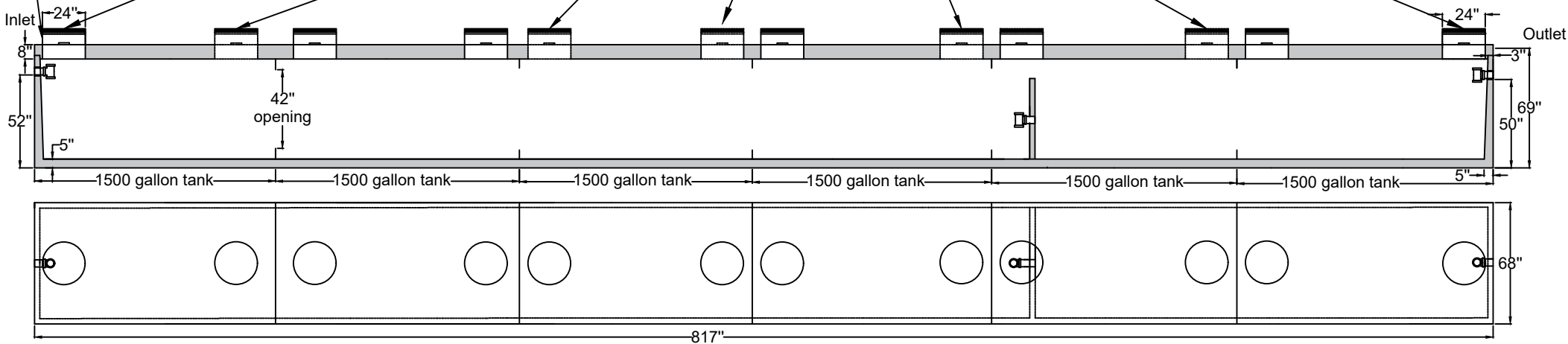

Top View
 (covers removed)

NOTES:

1. Conforms to IAPMO standard Z1000-2013.
2. Polypok Pipe seals used for inlet and outlet penetrations.
3. Tank is H2O Rated.
4. 6' of maximum Earth Cover.
5. Provide bedding of 3/8" rock min of 4" thick for tank or redwood stringers laid long-ways for tank to sit on.
6. Excavation requirements to be minimum of 18" all around tank to allow for repairs if needed.
7. All measurements are in inches.
8. Trelleborg pipe seals provided at 42" opening. Please see attached document.

MODEL NUMBER: 9000GST-T
WEIGHT: 108,000lbs

* for more information, please contact Code Precast. Design subject to change.