

MODEL NUMBER: CP1818-T

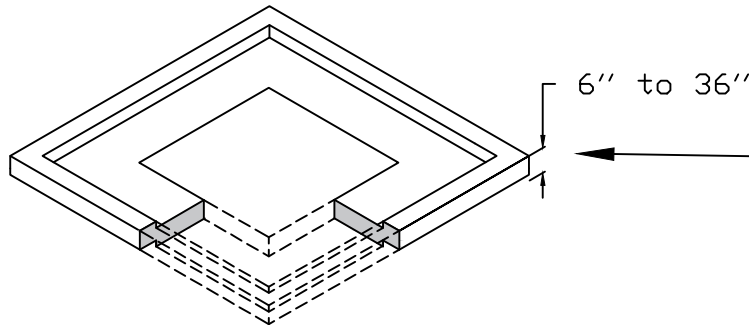

MODEL NUMBER: CP1818-R

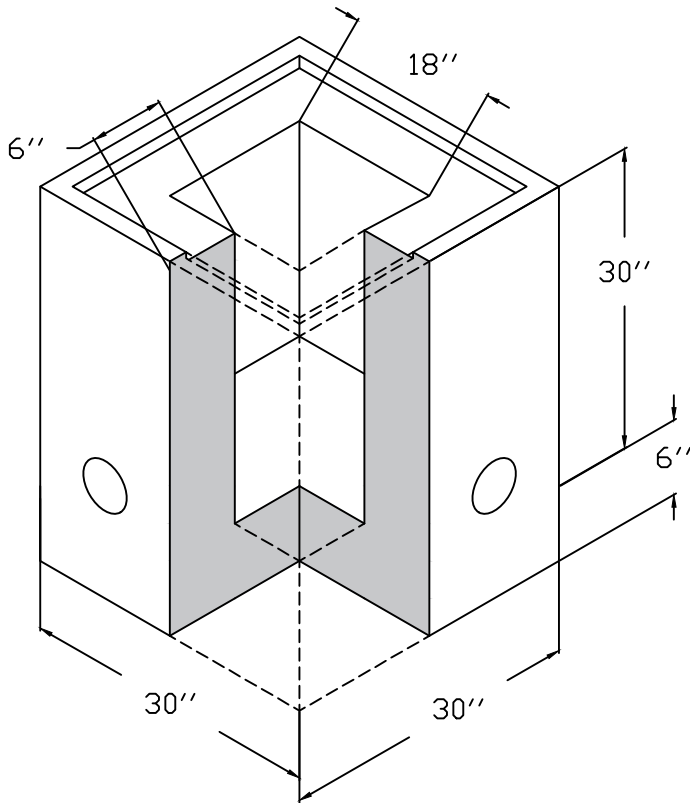

NOTES:

1. Concrete Strength: 4000 PSI at 28 days.
2. All measurements are in inches.
3. Max cored hole penetration is 16".
4. Trelleborg pipe seals provided for pipe penetrations. See attached document.
5. Frame and grate is H20 rated. Regular Steel or Hot dipped galvanized available. See attached document.
6. #4 A706 rebar OCEW used for reinforcement.

MODEL NUMBER: CP1818
WEIGHT: Varies

* for more information, please contact Code Precast. Design subject to change.